



# Bivona™ Silicone Tracheostomy Tubes

## Product Catalog

# Contents

Introduction.....	4
<b>Bivona TTS™</b> .....	<b>5</b>
Bivona TTS Adult Tracheostomy Tubes (Cuffed) .....	5
Bivona TTS Neonatal Tracheostomy Tubes (Cuffed "V" Neck Flange).....	5
Bivona TTS Neonatal Tracheostomy Tubes (Cuffed Straight Neck Flange)*.....	5
Bivona TTS Pediatric Tracheostomy Tubes (Cuffed "V" Neck Flange)*.....	5
Bivona TTS Pediatric Tracheostomy Tubes (Cuffed Straight Neck Flange)*.....	6
<b>Bivona TTS FlexTend™</b> .....	<b>7</b>
Bivona TTS Neonatal FlexTend Tracheostomy Tubes (Cuff V Neck Flange).....	7
Bivona TTS Neonatal FlexTend Tracheostomy Tubes (Cuff Straight Neck Flange).....	7
Bivona TTS Pediatric FlexTend Tracheostomy Tubes (Cuff V Neck Flange).....	7
Bivona TTS Pediatric FlexTend Tracheostomy Tubes (Cuff Straight Neck Flange).....	7
<b>Bivona TTS FlexTend Plus™</b> .....	<b>8</b>
Bivona TTS Pediatric FlexTend Plus Tracheostomy Tubes (Cuff V Neck Flange).....	8
Bivona TTS Pediatric FlexTend Plus Tracheostomy Tubes (Cuff Straight Neck Flange).....	8
<b>Bivona FlexTend Plus</b> .....	<b>9</b>
Bivona Cuffless Neonatal FlexTend Tracheostomy Tubes (Extra Length, "V" Neck Flange).....	9
Bivona Cuffless Neonatal FlexTend Tracheostomy Tubes (Extra Length, Straight Neck Flange)*.....	9
Bivona Cuffless Pediatric FlexTend Tracheostomy Tubes (Extra Length, "V" Neck Flange)*.....	9
Bivona Cuffless Pediatric FlexTend Tracheostomy Tubes (Extra Length, "V" Neck Flange)*.....	9
Bivona Cuffless FlexTend Pediatric Tracheostomy Tubes (Straight Neck Flange, Extra Length)*.....	10
Bivona Cuffless FlexTend Pediatric Tracheostomy Tubes (Straight Neck Flange, Extra Length)*.....	10
<b>Bivona Aire-Cuf™</b> .....	<b>11</b>
Bivona Mid-Range Aire-Cuf Adult Tracheostomy Tubes.....	11
Bivona Mid-Range Aire-Cuf Adult Tracheostomy Tubes with Talk Attachment.....	11
Bivona Aire-Cuf Neonatal Tracheostomy Tubes ("V" Neck Flange)*.....	11
Bivona Aire-Cuf Neonatal Tracheostomy Tubes (Straight Neck Flange)*.....	12
Bivona Aire-Cuf Pediatric Tracheostomy Tubes ("V" Neck Flange)*.....	12
Bivona Aire-Cuf Pediatric Tracheostomy Tubes (Straight Neck Flange)*.....	12
<b>Bivona Fome-Cuf™</b> .....	<b>13</b>
Bivona Fome-Cuf Adult Tracheostomy Tubes.....	13
Bivona Fome-Cuf Adult Tracheostomy Tubes (with Talk Attachment).....	13
Bivona Fome-Cuf Neonatal Tracheostomy Tubes ("V" Neck Flange)*.....	13
Bivona Fome-Cuf Pediatric Tracheostomy Tubes ("V" Neck Flange)*.....	13

<b>Bivona Adjustable Hyperflex™</b> .....	14
Bivona TTS Adjustable Neck Flange Hyperflex Tracheostomy Tubes.....	14
Bivona Mid-Range Aire-Cuf Adjustable Neck Flange Hyperflex Tracheostomy Tubes.....	14
Bivona Uncuffed Tube Adjustable Neck Flange Hyperflex Paediatric “V” Neck Flange Tracheostomy Tubes* .....	14
<b>Bivona Fixed Flange Hyperflex</b> .....	15
Bivona Cuffless Extra Length Fixed Hyperflex Tracheostomy Tubes .....	15
Bivona TTS Extra Length Fixed Neck Flange Hyperflex Tracheostomy Tubes.....	15
Bivona Cuffed Extra Length Fixed Neck Flange Hyperflex Tracheostomy Tubes.....	15
<b>Bivona Cuffless/Uncuffed</b> .....	16
Bivona Cuffless Adult Tracheostomy Tubes .....	16
Bivona Uncuffed Neonatal Tracheostomy Tubes (“V” Neck Flange) .....	16
Bivona Uncuffed Neonatal Tracheostomy Tubes (Straight Neck Flange)* .....	16
Bivona Uncuffed Pediatric Tracheostomy Tubes (“V” Neck Flange)* .....	16
Bivona Uncuffed Pediatric Tracheostomy Tubes (Straight Neck Flange)* .....	17
<b>Bivona Customized Silicone Tracheostomy Tubes</b> .....	18
<b>Accessories</b> .....	18

Each tube comes individually packaged with obturator, disconnection wedge, and twill tape.

# Bivona Silicone Tracheostomy Tubes

---

Silicone offers important advantages over conventional tube materials:

## Softness and flexibility

For comfort, ease of use, and greater range of mobility.

## Biocompatibility

Hydrophobic and hypoallergenic, tissue-friendly and easy to clean.

## Durability

Robust for reliable reprocessing, withstands repeated sanitization up to ten times (adult) and five times (for neonatal and pediatrics).

---

Bivona silicone tracheostomy tubes are available in a range of tube configuration options to suit each, age, size, and application requirements. Customized Bivona silicone tubes are available.



### For comfort

A variety of tubes designed to aid in patient comfort:

- › allows 15 mm connector to be distal from chin.
- › reduces the risk of device-related pressure ulcers.
- › option to utilize self-expanding cuff to mitigate risks of over inflation.

### For design

Integrating unique features to aid patient comfort, ease-of-use and avoidance of contamination.

### For useability and safety

Hydrophobic material for easy cleaning, free from DEHP, latex and plasticizers.

### For cost-efficiency

Bivona tubes can be cleaned and sanitized for up to ten re-insertions for adult sizes or five times for neonatal and pediatric sizes.



### For choice

Combining the softness and flexibility of silicone, with an extensive range of size and shape options for all ages.

# Bivona TTS

The TTS cuff design offers the benefits of a cuff with the profile of a cuffless tube. When the silicone cuff is totally deflated it adds no significant dimension to the outer diameter of the tube's shaft, yet it can be partially or completely inflated for varied airway management needs.

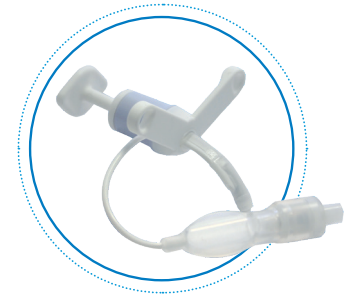

670180

Bivona TTS Adult Tracheostomy Tubes (Cuffed)							
Product Code	Tube Size (mm)	Tube I.D. (mm)	Tube O.D. (mm)	Tube Length (mm)	Tube Angle	Cuff Resting Diameter (mm)	Units Per Case
670150	5.0	5.0	7.4	60.0	100°	9.5	1
670160	6.0	6.0	8.8	70.0	100°	11.0	1
670170	7.0	7.0	10.0	80.0	100°	12.0	1
670175	7.5	7.5	10.5	80.0	100°	12.5	1
670180	8.0	8.0	11.0	88.0	100°	13.0	1
670185	8.5	8.5	11.8	88.0	100°	14.0	1
670190	9.0	9.0	12.3	98.0	100°	14.5	1



67N030

Bivona TTS Neonatal Tracheostomy Tubes (Cuffed "V" Neck Flange)							
Product Code	Tube Size (mm)	Tube I.D. (mm)	Tube O.D. (mm)	Tube Length (mm)	Tube Angle	Cuff Resting Diameter (mm)	Units Per Case
67N025	2.5	2.5	4.0	30.0	120°	4.0	1
67N030	3.0	3.0	4.7	32.0	120°	4.7	1
67N035	3.5	3.5	5.3	34.0	120°	5.3	1
67N040	4.0	4.0	6.0	36.0	120°	6.0	1



67SN030

Bivona TTS Neonatal Tracheostomy Tubes (Cuffed Straight Neck Flange)							
Product Code	Tube Size (mm)	Tube I.D. (mm)	Tube O.D. (mm)	Tube Length (mm)	Tube Angle	Cuff Resting Diameter (mm)	Units Per Case
67SN025	2.5	2.5	4.0	30.0	120°	4.0	1
67SN030	3.0	3.0	4.7	32.0	120°	4.7	1
67SN035	3.5	3.5	5.3	34.0	120°	5.3	1
67SN040	4.0	4.0	6.0	36.0	120°	6.0	1



67P045

Bivona TTS Pediatric Tracheostomy Tubes (Cuffed "V" Neck Flange)							
Product Code	Tube Size (mm)	Tube I.D. (mm)	Tube O.D. (mm)	Tube Length (mm)	Tube Angle	Cuff Resting Diameter (mm)	Units Per Case
67P025	2.5	2.5	4.0	38.0	120°	4.0	1
67P030	3.0	3.0	4.7	39.0	120°	4.7	1
67P035	3.5	3.5	5.3	40.0	120°	5.3	1
67P040	4.0	4.0	6.0	41.0	120°	6.0	1
67P045	4.5	4.5	6.7	42.0	120°	6.7	1
67P050	5.0	5.0	7.3	44.0	120°	7.3	1
67P055	5.5	5.5	8.0	46.0	120°	8.0	1

# Bivona TTS



67SP045

Bivona TTS Pediatric Tracheostomy Tubes (Cuffed Straight Neck Flange)*							
Product Code	Tube Size (mm)	Tube I.D. (mm)	Tube O.D. (mm)	Tube Length (mm)	Tube Angle	Cuff Resting Diameter (mm)	Units Per Case
67SP025	2.5	2.5	4.0	38.0	120°	4.0	1
67SP030	3.0	3.0	4.7	39.0	120°	4.7	1
67SP035	3.5	3.5	5.3	40.0	120°	5.3	1
67SP040	4.0	4.0	6.0	41.0	120°	6.0	1
67SP045	4.5	4.5	6.7	42.0	120°	6.7	1
67SP050	5.0	5.0	7.3	44.0	120°	7.3	1
67SP055	5.5	5.5	8.0	46.0	120°	8.0	1

# Bivona TTS FlexTend

Radiopaque silicone tracheostomy tubes with a wire reinforced extension, proximal to the neck flange. The silicone cuff lays flat against the shaft with deflated. Proximal extension allows 15 mm connector to be distal from the chin. The tube has a clear inflation balloon with a one way valve and integral 15 mm connection. It is manufactured with Bivona SuperSlick™ formulation.



67NFP25

Bivona TTS Neonatal FlexTend Tracheostomy Tubes (Cuff V Neck Flange)*								
Product Code	Tube Size (mm)	Tube I.D. (mm)	Tube O.D. (mm)	Proximal Length (mm)	Distal Length (mm)	Tube Angle	Cuff Resting Diameter (mm)	Units Per Case
67NFP25	2.5	2.5	4.0	20.0	30.0	120°	4.0	1
67NFP30	3.0	3.0	4.7	20.0	32.0	120°	4.7	1
67NFP35	3.5	3.5	5.3	20.0	34.0	120°	5.3	1
67NFP40	4.0	4.0	6.0	20.0	36.0	120°	6.0	1



67NFPS25

Bivona TTS Neonatal FlexTend Tracheostomy Tubes (Cuff Straight Neck Flange)*								
Product Code	Tube Size (mm)	Tube I.D. (mm)	Tube O.D. (mm)	Proximal Length (mm)	Distal Length (mm)	Tube Angle	Cuff Resting Diameter (mm)	Units Per Case
67NFPS25	2.5	2.5	4.0	20.0	30.0	120°	4.0	1
67NFPS30	3.0	3.0	4.7	20.0	32.0	120°	4.7	1
67NFPS35	3.5	3.5	5.3	20.0	34.0	120°	5.3	1
67NFPS40	4.0	4.0	6.0	20.0	36.0	120°	6.0	1



67PFS25

Bivona TTS Pediatric FlexTend Tracheostomy Tubes (Cuff V Neck Flange)*								
Product Code	Tube Size (mm)	Tube I.D. (mm)	Tube O.D. (mm)	Proximal Length (mm)	Distal Length (mm)	Tube Angle	Cuff Resting Diameter (mm)	Units Per Case
67PFS25	2.5	2.5	4.0	20.0	38.0	120°	4.0	1
67PFS30	3.0	3.0	4.7	20.0	39.0	120°	4.7	1
67PFS35	3.5	3.5	5.3	20.0	40.0	120°	5.3	1
67PFS40	4.0	4.0	6.0	20.0	41.0	120°	6.0	1
67PFS45	4.5	4.5	6.7	30.0	42.0	120°	6.7	1
67PFS50	5.0	5.0	7.3	30.0	44.0	120°	7.3	1
67PFS55	5.5	5.5	8.0	30.0	46.0	120°	8.0	1



67PFSS25

Bivona TTS Pediatric FlexTend Tracheostomy Tubes (Cuff Straight Neck Flange)*								
Product Code	Tube Size (mm)	Tube I.D. (mm)	Tube O.D. (mm)	Proximal Length (mm)	Distal Length (mm)	Tube Angle	Cuff Resting Diameter (mm)	Units Per Case
67PFSS25	2.5	2.5	4.0	20.0	38.0	120°	4.0	1
67PFSS30	3.0	3.0	4.7	20.0	39.0	120°	4.7	1
67PFSS35	3.5	3.5	5.3	20.0	40.0	120°	5.3	1
67PFSS40	4.0	4.0	6.0	20.0	41.0	120°	6.0	1
67PFSS45	4.5	4.5	6.7	30.0	42.0	120°	6.7	1
67PFSS50	5.0	5.0	7.3	30.0	44.0	120°	7.3	1
67PFSS55	5.5	5.5	8.0	30.0	46.0	120°	8.0	1

# Bivona TTS FlexTend Plus

Radiopaque silicone tracheostomy tubes with a wire reinforced extension, proximal to the neck flange. The silicone cuff lays flat against the shaft with deflated. Proximal extension allows 15 mm connector to be distal from the chin. The tube has a clear inflation balloon with a one way valve and integral 15 mm connection. FlexTend Plus tubes also provide additional distal length for patients requiring additional overall length. It is manufactured with Bivona SuperSlick™.

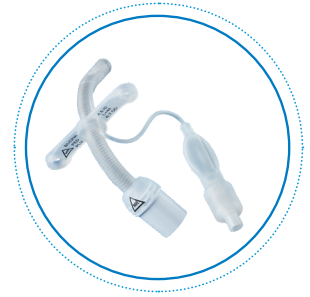

67PFP40

## Bivona TTS Pediatric FlexTend Plus Tracheostomy Tubes (Cuff V Neck Flange)\*

Product Code	Tube Size (mm)	Tube I.D. (mm)	Tube O.D. (mm)	Proximal Length (mm)	Distal Length (mm)	Tube Angle	Cuff Resting Diameter (mm)	Units Per Case
67PFP40	4.0	4.0	6.0	30.0	44.0	120°	4.0	1
67PFP45	4.5	4.5	6.7	30.0	48.0	120°	4.7	1
67PFP50	5.0	5.0	7.3	30.0	50.0	120°	5.3	1
67PFP55	5.5	5.5	8.0	30.0	52.0	120°	6.0	1
67PFP60	6.0	6.0	8.7	30.0	56.0	120°	6.7	1



## Bivona TTS Pediatric FlexTend Plus Tracheostomy Tubes (Cuff Straight Neck Flange)\*

Product Code	Tube Size (mm)	Tube I.D. (mm)	Tube O.D. (mm)	Proximal Length (mm)	Distal Length (mm)	Tube Angle	Cuff Resting Diameter (mm)	Units Per Case
67PFPS40	4.0	4.0	6.0	30.0	44.0	120°	4.0	1
67PFPS45	4.5	4.5	6.7	30.0	48.0	120°	4.7	1
67PFPS50	5.0	5.0	7.3	30.0	50.0	120°	5.3	1
67PFPS55	5.5	5.5	8.0	30.0	52.0	120°	6.0	1
67PFPS60	6.0	6.0	8.7	30.0	56.0	120°	6.7	1



# Bivona FlexTend Plus

Reinforced proximal and distal sections provide a high level of kink and crush resistance. Extended proximal tube allows 15 mm connector to be distal from the chin.



Hospital



Home



MR Conditional



60NFP30

Bivona Cuffless Neonatal FlexTend Tracheostomy Tubes (Extra Length, "V" Neck Flange)								
Product Code	Tube Size (mm)	Tube I.D. (mm)	Tube O.D. (mm)	Proximal Length (mm)	Distal Length (mm)	Tube Angle	Cuff Resting Diameter (mm)	Units Per Case
60NFP25	2.5	2.5	4.0	20.0	30.0	120°	N/A	1
60NFP30	3.0	3.0	4.7	20.0	32.0	120°	N/A	1
60NFP35	3.5	3.5	5.3	20.0	34.0	120°	N/A	1
60NFP40	4.0	4.0	6.0	20.0	36.0	120°	N/A	1



60NFPS35

Bivona Cuffless Neonatal FlexTend Tracheostomy Tubes (Extra Length, Straight Neck Flange)*								
Product Code	Tube Size (mm)	Tube I.D. (mm)	Tube O.D. (mm)	Proximal Length (mm)	Distal Length (mm)	Tube Angle	Cuff Resting Diameter (mm)	Units Per Case
60NFPS25	2.5	2.5	4.0	20.0	30.0	120°	N/A	1
60NFPS30	3.0	3.0	4.7	20.0	32.0	120°	N/A	1
60NFPS35	3.5	3.5	5.3	20.0	34.0	120°	N/A	1
60NFPS40	4.0	4.0	6.0	20.0	36.0	120°	N/A	1



60PFS40

Bivona Cuffless Pediatric FlexTend Tracheostomy Tubes (Extra Length, "V" Neck Flange)*								
Product Code	Tube Size (mm)	Tube I.D. (mm)	Tube O.D. (mm)	Proximal Length (mm)	Distal Length (mm)	Tube Angle	Cuff Resting Diameter (mm)	Units Per Case
60PFS25	2.5	2.5	4.0	20.0	38.0	120°	N/A	1
60PFS30	3.0	3.0	4.7	20.0	39.0	120°	N/A	1
60PFS35	3.5	3.5	5.3	20.0	40.0	120°	N/A	1
60PFS40	4.0	4.0	6.0	20.0	41.0	120°	N/A	1
60PFS45	4.5	4.5	6.7	30.0	42.0	120°	N/A	1
60PFS50	5.0	5.0	7.3	30.0	44.0	120°	N/A	1
60PFS55	5.5	5.5	8.0	30.0	46.0	120°	N/A	1



60PFP45

Bivona Cuffless Pediatric FlexTend Tracheostomy Tubes (Extra Length, "V" Neck Flange)*								
Product Code	Tube Size (mm)	Tube I.D. (mm)	Tube O.D. (mm)	Proximal Length (mm)	Distal Length (mm)	Tube Angle	Cuff Resting Diameter (mm)	Units Per Case
60PFP40	4.0	4.0	6.0	30.0	44.0	120°	N/A	1
60PFP45	4.5	4.5	6.7	30.0	48.0	120°	N/A	1
60PFP50	5.0	5.0	7.3	30.0	50.0	120°	N/A	1
60PFP55	5.5	5.5	8.0	30.0	52.0	120°	N/A	1
60PFP60	6.0	6.0	8.7	30.0	56.0	120°	N/A	1

# Bivona FlexTend Plus



60PFPS50

Bivona Cuffless FlexTend Pediatric Tracheostomy Tubes (Straight Neck Flange, Extra Length)*								
Product Code	Tube Size (mm)	Tube I.D. (mm)	Tube O.D. (mm)	Proximal Length (mm)	Distal Length (mm)	Tube Angle	Cuff Resting Diameter (mm)	Units Per Case
60PFPS40	4.0	4.0	6.0	30.0	44.0	120°	N/A	1
60PFPS45	4.5	4.5	6.7	30.0	48.0	120°	N/A	1
60PFPS50	5.0	5.0	7.3	30.0	50.0	120°	N/A	1
60PFSS55	5.5	5.5	8.0	30.0	52.0	120°	N/A	1
60PFSS60	6.0	6.0	8.7	30.0	56.0	120°	N/A	1



60PFSS25

Bivona Cuffless FlexTend Pediatric Tracheostomy Tubes (Straight Neck Flange, Extra Length)*								
Product Code	Tube Size (mm)	Tube I.D. (mm)	Tube O.D. (mm)	Proximal Length (mm)	Distal Length (mm)	Tube Angle	Cuff Resting Diameter (mm)	Units Per Case
60PFSS25	2.5	2.5	4.0	20.0	38.0	120°	N/A	1
60PFSS30	3.0	3.0	4.7	20.0	39.0	120°	N/A	1
60PFSS35	3.5	3.5	5.3	20.0	40.0	120°	N/A	1
60PFSS40	4.0	4.0	6.0	20.0	41.0	120°	N/A	1
60PFSS45	4.5	4.5	6.7	30.0	42.0	120°	N/A	1
60PFSS50	5.0	5.0	7.3	30.0	44.0	120°	N/A	1
60PFSS55	5.5	5.5	8.0	30.0	46.0	120°	N/A	1

# Bivona Aire-Cuf

A flexible, adjustable tube with a soft secure cuff. Neonatal and pediatric tubes are reinforced to give a high level of kink and crush resistance. Select adult configurations feature a talk attachment allowing vocalization for ventilator dependent patients with viable vocal cords.

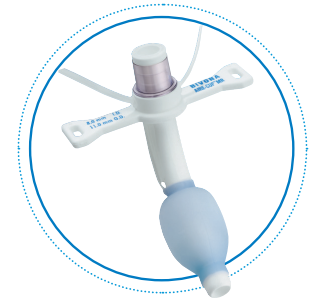

750160

Bivona Mid-Range Aire-Cuf Adult Tracheostomy Tubes							
Product Code	Tube Size (mm)	Tube I.D. (mm)	Tube O.D. (mm)	Tube Length (mm)	Tube Angle	Cuff Resting Diameter (mm)	Units Per Case
750150	5.0	5.0	7.4	60.0	100°	17.0	1
750160	6.0	6.0	8.8	70.0	100°	18.0	1
750170	7.0	7.0	10.0	80.0	100°	21.0	1
750180	8.0	8.0	11.0	88.0	100°	25.0	1
750190	9.0	9.0	12.3	98.0	100°	28.0	1
750195	9.5	9.5	13.3	98.0	100°	28.0	1



755180

Bivona Mid-Range Aire-Cuf Adult Tracheostomy Tubes with Talk Attachment							
Product Code	Tube Size (mm)	Tube I.D. (mm)	Tube O.D. (mm)	Tube Length (mm)	Tube Angle	Cuff Resting Diameter (mm)	Units Per Case
755150-SM	5.0	5.0	7.3	60.0	100°	17.0	1
755160-SM	6.0	6.0	8.7	70.0	100°	18.0	1
755170-SM	7.0	7.0	10.0	80.0	100°	21.0	1
755180-SM	8.0	8.0	11.0	88.0	100°	25.0	1
755190-SM	9.0	9.0	12.3	98.0	100°	28.0	1
755195-SM	9.5	9.5	13.3	98.0	100°	28.0	1



65N035

Bivona Aire-Cuf Neonatal Tracheostomy Tubes ("V" Neck Flange)*							
Product Code	Tube Size (mm)	Tube I.D. (mm)	Tube O.D. (mm)	Tube Length (mm)	Tube Angle	Cuff Resting Diameter (mm)	Units Per Case
65N025	2.5	2.5	4.0	30.0	120°	12.0	1
65N030	3.0	3.0	4.7	32.0	120°	14.0	1
65N035	3.5	3.5	5.3	34.0	120°	14.0	1
65N040	4.0	4.0	6.0	36.0	120°	18.0	1

# Bivona Aire-Cuf



65SN025

Bivona Aire-Cuf Neonatal Tracheostomy Tubes (Straight Neck Flange)*							
Product Code	Tube Size (mm)	Tube I.D. (mm)	Tube O.D. (mm)	Tube Length (mm)	Tube Angle	Cuff Resting Diameter (mm)	Units Per Case
65SN025	2.5	2.5	4.0	30.0	120°	12.0	1
65SN030	3.0	3.0	4.7	32.0	120°	14.0	1
65SN035	3.5	3.5	5.3	34.0	120°	14.0	1
65SN040	4.0	4.0	6.0	36.0	120°	18.0	1



65P030

Bivona Aire-Cuf Pediatric Tracheostomy Tubes ("V" Neck Flange)*							
Product Code	Tube Size (mm)	Tube I.D. (mm)	Tube O.D. (mm)	Tube Length (mm)	Tube Angle	Cuff Resting Diameter (mm)	Units Per Case
65P025	2.5	2.5	4.0	38.0	120°	12.0	1
65P030	3.0	3.0	4.7	39.0	120°	14.0	1
65P035	3.5	3.5	5.3	40.0	120°	14.0	1
65P040	4.0	4.0	6.0	41.0	120°	18.0	1
65P045	4.5	4.5	6.7	42.0	120°	18.0	1
65P050	5.0	5.0	7.3	44.0	120°	20.0	1
65P055	5.5	5.5	8.0	46.0	120°	20.0	1



65SP030

Bivona Aire-Cuf Pediatric Tracheostomy Tubes (Straight Neck Flange)*							
Product Code	Tube Size (mm)	Tube I.D. (mm)	Tube O.D. (mm)	Tube Length (mm)	Tube Angle	Cuff Resting Diameter (mm)	Units Per Case
65SP025	2.5	2.5	4.0	38.0	120°	12.0	1
65SP030	3.0	3.0	4.7	39.0	120°	14.0	1
65SP035	3.5	3.5	5.3	40.0	120°	14.0	1
65SP040	4.0	4.0	6.0	41.0	120°	18.0	1
65SP045	4.5	4.5	6.7	42.0	120°	18.0	1
65SP050	5.0	5.0	7.3	44.0	120°	20.0	1
65SP055	5.5	5.5	8.0	46.0	120°	20.0	1

# Bivona Fome-Cuf

The self expanding cuff helps reduce the risk of over or under-inflation associated with traditional cuffs. Select adult configurations feature a talk attachment allowing vocalization for ventilator dependent patients with viable vocal cords.

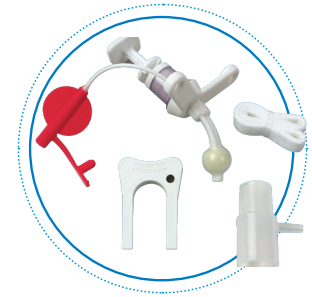

850180

Bivona Fome-Cuf Adult Tracheostomy Tubes							
Product Code	Tube Size (mm)	Tube I.D. (mm)	Tube O.D. (mm)	Tube Length (mm)	Tube Angle	Cuff Resting Diameter (mm)	Units Per Case
850150	5.0	5.0	7.3	60.0	100°	20.0	1
850160	6.0	6.0	8.7	70.0	100°	30.0	1
850170	7.0	7.0	10.0	80.0	100°	32.0	1
850180	8.0	8.0	11.0	88.0	100°	33.0	1
850190	9.0	9.0	12.3	98.0	100°	33.0	1
850195	9.5	9.5	13.3	98.0	100°	33.0	1

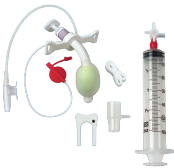

855180

Bivona Fome-Cuf Adult Tracheostomy Tubes (with Talk Attachment)							
Product Code	Tube Size (mm)	Tube I.D. (mm)	Tube O.D. (mm)	Tube Length (mm)	Tube Angle	Cuff Resting Diameter (mm)	Units Per Case
855150	5.0	5.0	7.3	60.0	100°	20.0	1
855160	6.0	6.0	8.7	70.0	100°	30.0	1
855170	7.0	7.0	10.0	80.0	100°	32.0	1
855180	8.0	8.0	11.0	88.0	100°	33.0	1
855190	9.0	9.0	12.3	98.0	100°	33.0	1

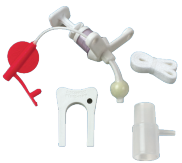

85N030

Bivona Fome-Cuf Neonatal Tracheostomy Tubes ("V" Neck Flange)*							
Product Code	Tube Size (mm)	Tube I.D. (mm)	Tube O.D. (mm)	Tube Length (mm)	Tube Angle	Cuff Resting Diameter (mm)	Units Per Case
85N030	3.0	3.0	4.7	32.0	N/A	14.0	1
85N035	3.5	3.5	5.3	34.0	N/A	14.0	1
85N040	4.0	4.0	6.0	36.0	N/A	18.0	1



85P035

Bivona Fome-Cuf Pediatric Tracheostomy Tubes ("V" Neck Flange)*							
Product Code	Tube Size (mm)	Tube I.D. (mm)	Tube O.D. (mm)	Tube Length (mm)	Tube Angle	Cuff Resting Diameter (mm)	Units Per Case
85P025	2.5	2.5	4.0	38.0	N/A	12.0	1
85P030	3.0	3.0	4.7	39.0	N/A	14.0	1
85P035	3.5	3.5	5.3	40.0	N/A	14.0	1
85P040	4.0	4.0	6.0	41.0	N/A	18.0	1
85P045	4.5	4.5	6.7	42.0	N/A	18.0	1
85P050	5.0	5.0	7.3	44.0	N/A	20.0	1
85P055	5.5	5.5	8.0	46.0	N/A	20.0	1

# Bivona Adjustable Hyperflex

Adjustable flange tubes allow for immediate modification of flange position to meet a variety of patient needs. It can be adjusted for horizontal and vertical shaft drop to accommodate unusual anatomy or pathology. Flexible wire-reinforced silicone shafts provide improved kink and crush resistance.

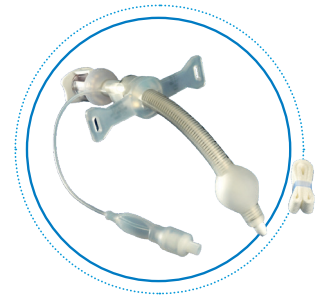

Bivona TTS Adjustable Neck Flange Hyperflex Tracheostomy Tubes							
Product Code	Tube Size (mm)	Tube I.D. (mm)	Tube O.D. (mm)	Tube Length (mm)	Tube Angle	Cuff Resting Diameter (mm)	Units Per Case
67HA60	6.0	6.0	9.2	110.0	180°	11.0	1
67HA70	7.0	7.0	10.6	120.0	180°	12.0	1
67HA80	8.0	8.0	11.7	130.0	180°	13.0	1
67HA90	9.0	9.0	12.9	140.0	180°	14.5	1



Bivona Mid-Range Aire-Cuf Adjustable Neck Flange Hyperflex Tracheostomy Tubes							
Product Code	Tube Size (mm)	Tube I.D. (mm)	Tube O.D. (mm)	Tube Length (mm)	Tube Angle	Cuff Resting Diameter (mm)	Units Per Case
75HA60	6.0	6.0	9.2	110.0	180°	18.0	1
75HA70	7.0	7.0	10.6	120.0	180°	21.0	1
75HA80	8.0	8.0	11.7	130.0	180°	25.0	1
75HA90	9.0	9.0	12.9	140.0	180°	28.0	1



Bivona Uncuffed Tube Adjustable Neck Flange Hyperflex Paediatric "V" Neck Flange Tracheostomy Tubes*							
Product Code	Tube Size (mm)	Tube I.D. (mm)	Tube O.D. (mm)	Maximum Usable Tube Length (mm)	Tube Angle	Cuff Resting Diameter (mm)	Units Per Case
60HA25	2.5	2.5	4.0	55.0	180°	N/A	1
60HA30	3.0	3.0	4.7	60.0	180°	N/A	1
60HA35	3.5	3.5	5.3	65.0	180°	N/A	1
60HA40	4.0	4.0	6.0	70.0	180°	N/A	1
60HA45	4.5	4.5	6.7	75.0	180°	N/A	1
60HA50	5.0	5.0	7.3	80.0	180°	N/A	1
60HA55	5.5	5.5	8.0	85.0	180°	N/A	1

# Bivona Fixed Flange Hyperflex

The fixed flange tube provides a more permanent solution for patients who require extra vertical and horizontal length. Flexible wire-reinforced silicone shafts provide improved kink and crush resistance.

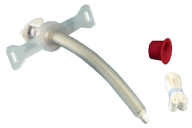

60AFHXL70

Bivona Cuffless Extra Length Fixed Hyperflex Tracheostomy Tubes*							
Product Code	Tube Size (mm)	Tube I.D. (mm)	Tube O.D. (mm)	Tube Length (mm)	Tube Angle	Cuff Resting Diameter (mm)	Units Per Case
60AFHXL60	6.0	6.0	9.2	100.0	180°	N/A	1
60AFHXL70	7.0	7.0	10.6	110.0	180°	N/A	1
60AFHXL80	8.0	8.0	11.7	120.0	180°	N/A	1
60AFHXL90	9.0	9.0	12.9	130.0	180°	N/A	1



67FHXL70

Bivona TTS Extra Length Fixed Neck Flange Hyperflex Tracheostomy Tubes*							
Product Code	Tube Size (mm)	Tube I.D. (mm)	Tube O.D. (mm)	Tube Length (mm)	Tube Angle	Cuff Resting Diameter (mm)	Units Per Case
67FHXL60	6.0	6.0	9.2	100.0	180°	11.0	1
67FHXL70	7.0	7.0	10.6	110.0	180°	12.0	1
67FHXL80	8.0	8.0	11.7	120.0	180°	13.0	1
67FHXL90	9.0	9.0	12.9	130.0	180°	14.5	1



75FHXL60

Bivona Cuffed Extra Length Fixed Neck Flange Hyperflex Tracheostomy Tubes*							
Product Code	Tube Size (mm)	Tube I.D. (mm)	Tube O.D. (mm)	Tube Length (mm)	Tube Angle	Cuff Resting Diameter (mm)	Units Per Case
75FHXL60	6.0	6.0	9.2	100.0	180°	18.0	1
75FHXL70	7.0	7.0	10.6	110.0	180°	21.0	1
75FHXL80	8.0	8.0	11.7	120.0	180°	25.0	1
75FHXL90	9.0	9.0	12.9	130.0	180°	28.0	1

# Bivona Cuffless

When an uncuffed tube is indicated, the all silicone construction of this soft and flexible tube ensures comfort for the patient.



Hospital



Home



MR Conditional



60A160

Bivona Cuffless Adult Tracheostomy Tubes*							
Product Code	Tube Size (mm)	Tube I.D. (mm)	Tube O.D. (mm)	Tube Length (mm)	Tube Angle	Cuff Resting Diameter (mm)	Units Per Case
60A150	5.0	5.0	7.4	60.0	N/A	N/A	1
60A160	6.0	6.0	8.8	70.0	N/A	N/A	1
60A170	7.0	7.0	10.0	80.0	N/A	N/A	1
60A180	8.0	8.0	11.0	88.0	N/A	N/A	1
60A190	9.0	9.0	12.3	98.0	N/A	N/A	1

\* Products listed above are MR Safe.



60N030

Bivona Uncuffed Neonatal Tracheostomy Tubes ("V" Neck Flange)**							
Product Code	Tube Size (mm)	Tube I.D. (mm)	Tube O.D. (mm)	Tube Length (mm)	Tube Angle	Cuff Resting Diameter (mm)	Units Per Case
60N025	2.5	2.5	4.0	30.0	120°	N/A	1
60N030	3.0	3.0	4.7	32.0	120°	N/A	1
60N035	3.5	3.5	5.3	34.0	120°	N/A	1
60N040	4.0	4.0	6.0	36.0	120°	N/A	1



60SN025

Bivona Uncuffed Neonatal Tracheostomy Tubes (Straight Neck Flange)**							
Product Code	Tube Size (mm)	Tube I.D. (mm)	Tube O.D. (mm)	Tube Length (mm)	Tube Angle	Cuff Resting Diameter (mm)	Units Per Case
60SN025	2.5	2.5	4.0	30.0	120°	N/A	1
60SN030	3.0	3.0	4.7	32.0	120°	N/A	1
60SN035	3.5	3.5	5.3	34.0	120°	N/A	1
60SN040	4.0	4.0	6.0	36.0	120°	N/A	1



60P040

Bivona Uncuffed Pediatric Tracheostomy Tubes ("V" Neck Flange)**							
Product Code	Tube Size (mm)	Tube I.D. (mm)	Tube O.D. (mm)	Tube Length (mm)	Tube Angle	Cuff Resting Diameter (mm)	Units Per Case
60P025	2.5	2.5	4.0	38.0	120°	N/A	1
60P030	3.0	3.0	4.7	39.0	120°	N/A	1
60P035	3.5	3.5	5.3	40.0	120°	N/A	1
60P040	4.0	4.0	6.0	41.0	120°	N/A	1
60P045	4.5	4.5	6.7	42.0	120°	N/A	1
60P050	5.0	5.0	7.3	44.0	120°	N/A	1
60P055	5.5	5.5	8.0	46.0	120°	N/A	1



# Bivona Cuffless



60SP040

Bivona Uncuffed Pediatric Tracheostomy Tubes (Straight Neck Flange)*							
Product Code	Tube Size (mm)	Tube I.D. (mm)	Tube O.D. (mm)	Tube Length (mm)	Tube Angle	Cuff Resting Diameter (mm)	Units Per Case
60SP025	2.5	2.5	4.0	38.0	120°	N/A	1
60SP030	3.0	3.0	4.7	39.0	120°	N/A	1
60SP035	3.5	3.5	5.3	40.0	120°	N/A	1
60SP040	4.0	4.0	6.0	41.0	120°	N/A	1
60SP045	4.5	4.5	6.7	42.0	120°	N/A	1
60SP050	5.0	5.0	7.3	44.0	120°	N/A	1
60SP055	5.5	5.5	8.0	46.0	120°	N/A	1

# Bivona Customized Silicone Tracheostomy Tubes

Treating a patient with difficult or unusual anatomy can be a challenge; getting that patient a proper fitting tracheostomy tube shouldn't be. Bivona Customization lab technicians can hand-craft a tube of soft, durable silicone to conform to the patient's neck, stoma, and trachea.

Designing a Bivona customized tracheostomy tube can be completed using our on-line templates.

Bivona customized tracheostomy tube delivery times:

- › Standard service (sterile): 3-4 weeks.
- › Standard service (non-sterile): 7 business days.
- › Express service (non-sterile): 3 business days.
- › Next-day service (non-sterile): shipped same day if order is received by 10 a.m. CST.
- › Next-day service (non-sterile): shipped same day if order is received by 12 p.m. CST (additional fees apply).

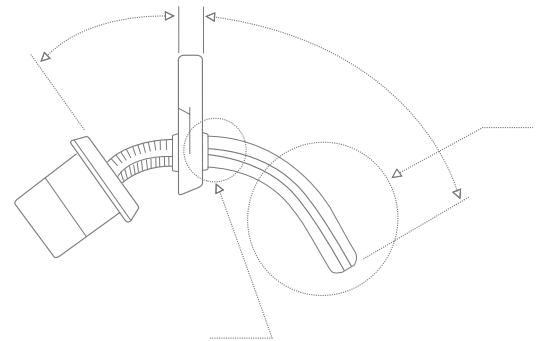

Visit [bivonacustom.com](http://bivonacustom.com) for more information or contact us at:

Phone: 1-800-424-8662

Email: [bivonacustomorder@icumed.com](mailto:bivonacustomorder@icumed.com)

## Accessories

Accessories		
Product Code	Description	Units Per Case
CARSWL	Carden Swivel Connector	1
CON15S	Side Port Connectors NS	50
REDCAP	15 mm Red Cap Plugs	26
DWG300	Disconnect Wedge 15 mm	25
002873	Portex™ HEPA Filter, Straight, 200-1500 mL	50
525351	Dual-Axis Swivel Adapter (Sterile)	50
570016	Thermovent™ T (Sterile)	50
570017	Thermovent T (Non-Sterile)	50
580011	Thermovent 600 HME	50
100/570/022	Thermovent T2 (Sterile)	50
100/575/010	Oxygen Delivery for HME Thermovent T Thermovent O <sub>2</sub>	10
100/582/000	Thermovent 1200 HME, Adult, Straight	20
625191	Fiber-Optic Bronchoscope Swivel Adapter (Sterile)	25

